

DUO-SORTER

OPTION C1

CONTAINER SIZE:
1.100 ltr

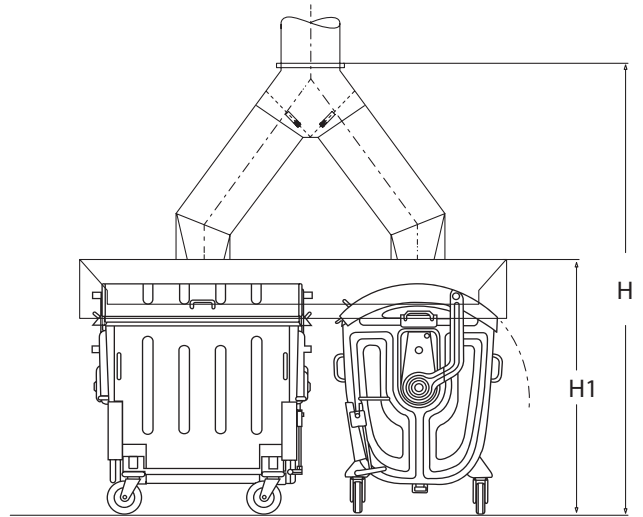

TOP-VIEW C1
container handling area
in front of the system

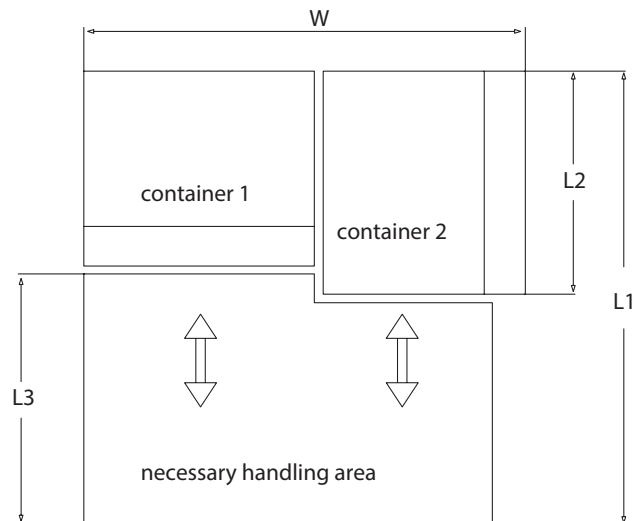

TECHNICAL DATA:

Dimensions	H	W	h1	L1	L2	L3
Standard	min. 2.500mm	3.600mm	1.500mm	2.800mm	1.400mm	1.400mm